

8 7 6 5 4 3 2 1

D

D

C

C

B

B

A

A

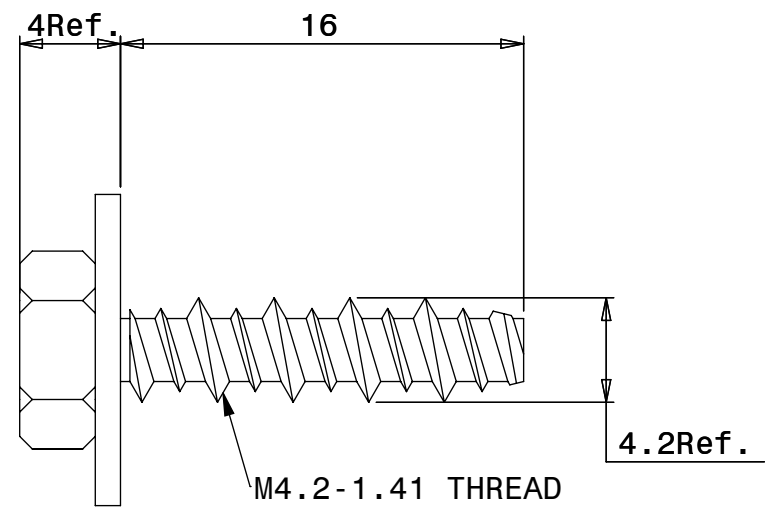
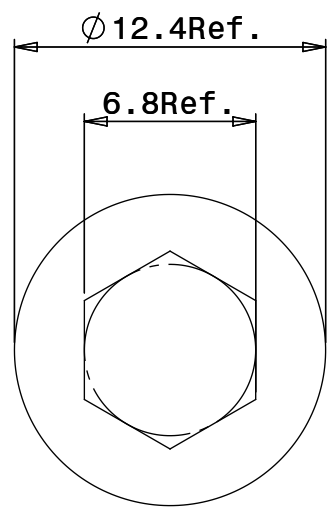

NOTES:  
 1. FINISH: BLACK E-COAT



LANSING, MICHIGAN 48911, USA  
<http://www.eisennet.com>

Information in this drawing  
 is provided for reference only

DWG NO. **500416**

TPLAST HI-LOW WASHER  
 SEMS HEX HD SCREWS

8 7 6 5 4 3 2 1